

Powering Low-Power RF Products

By Tobias Nass and Audun Andersen

Keywords

- *Power Supply*
- *Switch Mode Converter*
- *DC/DC Converter*
- *Switch Noise*
- *Sensitivity*
- *Efficiency*
- *PSRR*
- *CC1100*
- *CC1100E*
- *CC1101*
- *CC1110*
- *CC1111*
- *CC2430*
- *CC2500*
- *CC2510*
- *CC2511*
- *CC430*
- *TPS61xxx*
- *TPS62xxx*
- *TPS63000*

1 Introduction

Using linear voltage regulators is often the first choice when designing a low power wireless system, since the board space is often limited and a good power supply ripple rejection can be achieved. Considering system efficiency, especially for battery powered applications, a switch mode DC/DC converter might be a better choice.

DC/DC converters generate switching noise and can potentially affect the RF performance.

This design note gives an introduction to linear voltage regulators and DC/DC converters, and how they influence both performance and efficiency. Furthermore, some of Texas Instruments Low Power Wireless products are tested in combination with low power DC/DC converters from Texas Instruments. The last section gives an overview of the main design consideration when using DC/DC converter for low power wireless applications.

Table of Contents

KEYWORDS	1
1 INTRODUCTION	1
2 ABBREVIATIONS	2
3 EFFICIENT POWER SUPPLY FOR LOW POWER WIRELESS APPLICATIONS	3
3.1 BATTERIES	3
3.2 LINEAR VOLTAGE REGULATOR.....	5
3.3 SWITCH MODE DC/DC CONVERTER	6
3.4 EFFICIENCY ESTIMATION	8
3.4.1 Linear Voltage Regulator Efficiency Estimation.....	9
3.4.2 DC/DC Converter Efficiency Estimation	9
3.5 EFFICIENCY COMPARISON	9
4 SWITCH NOISE AND POTENTIAL INTERACTION WITH RF PERFORMANCE	10
4.1 LIGHT LOAD MODE.....	10
4.2 SWITCH NOISE.....	11
4.3 MEASUREMENTS	13
4.3.1 Measured Devices and Configurations.....	13
4.3.2 Measurement Results.....	15
5 CONCLUSION	15
5.1 FURTHER APPROACHES FOR REDUCING THE SWITCH NOISE IMPACT	15
6 REFERENCES	16
7 GENERAL INFORMATION	17
7.1 DOCUMENT HISTORY.....	17

2 Abbreviations

AMR	Automatic Meter Reading
EM	Evaluation Module
EVM	Evaluation Module
IF	Intermediate Frequency
ISM	Industrial, Scientific, Medical
LDO	Low dropout voltage regulator
LPW	Low Power Wireless
PFM	Pulse Frequency Modulation
POR	Power On Reset
PSRR	Power Supply Rejection Ratio
PWM	Pulse Width Modulation
RF	Radio Frequency
SMPS	Switch Mode Power Supply
SoC	System on Chip
TI	Texas Instruments
MCU	Micro Controller

3 Efficient Power Supply for Low Power Wireless Applications

Calculating the overall efficiency of a low power wireless system is quite complex and depends not only on the power supply efficiency, but also on the duty cycle between active and sleep mode as well as the quiescent current. In case of low duty cycle application like Automatic Meter Reading (AMR) or remote control, where the device wakes up only a few times a minute, an hour, or even a day, quiescent current is the dominating parameter in calculating the overall efficiency. For applications where the device is in active mode quite often, like wireless mouse/keyboard or headsets, the overall efficiency is dominated by the efficiency of the converter at high load currents.

Duty cycling and a highly efficient sleep mode are the basic requirements for a low power wireless system. Therefore, data is transmitted as fast as possible and the device is put in sleep mode whenever allowed by the application. The time between two cycle start ups is called cycle time and the ratio between the active time and the cycle time is called duty cycle. A typical load scenario for an RF application is shown in Figure 1.

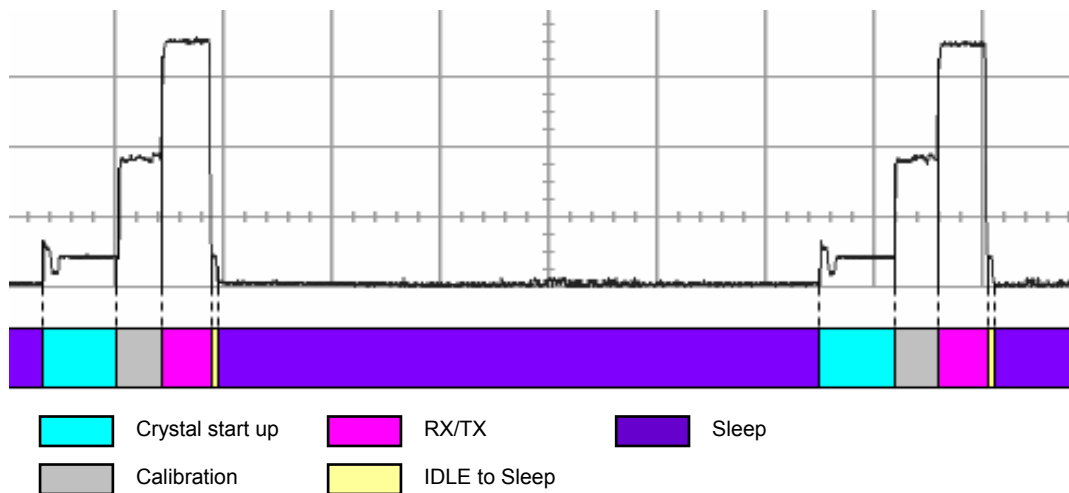

Figure 1. Typical Load Scenario Using Duty Cycling

The way average efficiency is calculated depends on whether a linear voltage regulator or a switch mode DC/DC converter is used. Since most TI LPW products are provided with an internal linear voltage regulator with a wide input supply voltage range of 1.8/2.0 V to 3.6 V, many applications can be directly battery powered without the need for any external regulator. However, the efficiency of the device decreases with increased supply voltage due to losses in the internal regulator. Therefore, the supply voltage should be as low as possible to obtain best possible efficiency.

The most common ways to power LPW applications are by using a linear voltage regulator, a switch mode DC/DC converter, or directly connecting a battery to the radio. The three following sections describe important aspects and efficiency for these three solutions.

3.1 Batteries

When wireless communication is required, there is almost always a battery involved. There are various battery chemistries available, both for primary (non-rechargeable) and secondary (rechargeable) applications. Common non-rechargeable chemistries include LiMnO₂, LiFeS₂, ZnMnO₂ (Alkaline), and traditional ZnC “dry cells”. Common rechargeable chemistries include Li-ion, NiMH, NiCd, and PbH₂SO₄. The latter two chemistries are rapidly falling out of favor due to their heavy metal content. PbH₂SO₄ batteries are generally used for bulk energy storage and are not available in common small form factors such as AA.

A comparison chart of various chemistries is shown below. Most of this data was taken from the Energizer™ website [15].

Chemistry	Primary or Secondary	Average Cell Voltage (V)	Form Factor	A-Hr Rating	Energy (W-hr)	Notes
LiMnO ₂	Primary	2.8	⅓ A	1.5	4.20	CR123 style
LiMnO ₂	Primary	2.8	CR2032	0.24	0.67	Coin cell
LiFeS ₂	Primary	1.5	AA	3.0	4.50	Energizer L91
LiFeS ₂	Primary	1.5	AAA	1.25	1.87	Energizer L92
ZnMnO ₂	Primary	1.25	AA	2.9	3.63	"Alkaline"
ZnMnO ₂	Primary	1.25	AAA	1.25	1.56	"Alkaline"
ZnMnO ₂	Primary	1.25	C	8	10	"Alkaline"
ZnMnO ₂	Primary	1.25	D	20	25	"Alkaline"
ZnC	Primary	1.25	AA	1.1	1.38	"Dry cell"
Li-ion	Secondary	3.6	A	~2.0	~7.2	"18650" style
NiMH	Secondary	1.2	AA	~2.2	~2.6	
NiCd	Secondary	1.2	AA	0.65	0.78	

Table 1. Battery Types

It is very common to stack battery cells to obtain higher voltages for compatibility with a particular signal chain, RF transmitter, or MCU. This is particularly true with "Alkaline", "dry cells", and NiMH. The discharge characteristics of the particular chemistry chosen as well as the voltage regulator used to power the device will determine the numbers of cells required to form the battery.

The battery size and form factor has an impact on the battery A-hr rating. The greater the battery volume, the more energy it will contain. Table 1 show that a CR123 style battery has roughly 4.2 W-hr of energy content. A stack of 3 AAA "Alkaline" batteries has roughly the same energy content, but will occupy a much larger volume.

Assume an application where it is desirable to have at least 2.7 V throughout the discharge cycle using a linear regulator powered by a stack of 3 "Alkaline" cells. When fresh, each "Alkaline" cell voltage will start at 1.6V, for an overall battery voltage of 4.8 V. Fully discharged, the cell voltage will drop to roughly 0.9V, yielding a sum battery potential of 2.7 V. From a quick look at the chart above, it is clear that if a LiMnO₂ battery were chosen for the same application, a single cell would suffice, at least as far as cell voltage is concerned, and no regulator would be required. Of course, LiMnO₂ cells are considerably more expensive and less common than "Alkaline" cells and are generally not economical in most applications.

The down-side of using a stack of "Alkaline" cells with a linear regulator is the energy lost during the process of regulation. On average, this stack of "Alkaline" cells will present 3.75 V to the input of the regulator. Since the efficiency of a linear regulator is V_{out}/V_{in} , the average efficiency of this solution over the life of the cells is only 72%. In this case, a buck converter such as the TPS62000 series having an efficiency of greater than 90% will increase the life time of the battery and extend the battery change interval.

It is usually desirable to maximize the battery change interval. In other words, the labor cost of changing a worn-out battery far outweighs the size or cost of the battery. In these situations the use of a single C or D size "Alkaline" cell may be considered. A single D cell contains the most energy of all the common cell sizes. Using a single D cell and an efficient switch-mode boost converter such as a member of the TPS61000 family, up to ~22 W-hr of energy at 3.3 V is available, assuming a peak switching efficiency of 90%. This is 5x the energy available from a CR123 cell, but at a fraction of the cost, even when the cost of the TPS61000 is considered.

More information about battery discharging can be found in the Application Report "Single-cell Battery Discharge Characteristics Using the TPS61070 Boost Converter" [4].

Powering the application directly from a battery will in most cases require that the application has some kind of battery monitoring capabilities. Most micro controllers (MCU) and radios have a Power On Reset (POR) feature which automatically starts up the device if the supply voltage reaches above a certain limit. If the application enters a high current load mode when the battery is close to being discharged it might cause the supply voltage to drop below the required level for operation. The drop in supply voltage will shut down the device and the current draw will be reduced. The reduction in the current load will result in an increased voltage from the battery and if the voltage increases above the POR limit, the device will start up again. This uncontrolled shutdown and start up of the system might lead to undesired operation and can be avoided by implementing a battery monitoring system. An ADC in the MCU or radio could be used to implement such a system.

TX and RX modes are typically high current load modes in a radio system. Thus, when the battery is close to being discharged, and if no battery monitoring system is in place, the system will shut down every time it tries to transmit or receive. A possible solution in this case is to turn on a low battery indicator and disable the RF capabilities until the battery is replaced.

3.2 Linear Voltage Regulator

A linear voltage regulator basically comprises a series pass transistor working as a variable resistor which is driven to generate a constant output voltage. This means the channel resistance of the transistor is set such that, independent of the load current I_{Load} , the required voltage drops over the transistor and the output voltage stays constant [1]. The power dissipated in the transistor is defined by Equation 1.

$$P_{diss} = (V_{in} - V_{out}) \cdot I_{load}$$

Equation 1. Power Dissipated

Due to internal reference and control circuitry an additional load independent, so called quiescent current I_q , is consumed by the converter. Thus, the voltage regulator efficiency is calculated as follows:

$$\eta = \frac{V_{out} \cdot \overline{I_{Load}}}{V_{in} (\overline{I_{Load}} + I_q)}$$

Equation 2. Voltage Regulator Efficiency

When the device is active mode, quiescent current can be neglected and the efficiency is defined by the ratio between output and input voltage. The maximum achievable efficiency is limited by the voltage ratio. In case of high voltage difference like converting 3.0 V of a lithium battery to 1.8 V, the efficiency is around 60%. In case of sleep mode, where the load current is very low, the quiescent current further reduces the efficiency.

Linear voltage regulators have good power supply ripple rejection (PSRR). This means that these regulators are able to provide a regulated output voltage with low ripple even if it experiences an input voltage with high ripple.

Low Drop-Out voltage regulators (LDOs) are special types of linear regulators which are able to convert the voltage even with a very low voltage difference between the input and output voltage. A common misunderstanding is that they are generally more efficient. Since LDOs can provide the desired output voltage with less difference between the input and output voltage, it is possible to utilize more of the energy in the battery. This leads to longer battery life time and higher system efficiency.

3.3 Switch Mode DC/DC Converter

Switch mode DC/DC converters, also called Switch Mode Power Supplies (SMPS), are required for some application. For instance a DC/DC converter can be used when the available voltage has to be boosted up because it is lower than the required supply voltage. Another reason for using a DC/DC converter could be to achieve better efficiency and thus longer battery lifetime. Depending on voltage ratio three basic topologies are available:

Buck: converts from high to low voltage

Boost: converts from low to high voltage

Buck-Boost: converts from low to high and high to low voltage

Buck converters are used in applications, where the available voltage is higher than the device supply voltage e.g. to supply the radio device with 1.8 V from a lithium primary battery with 3.0 V. To change the voltage level, the buck converter chops the input voltage with a fixed frequency while the duty cycle is decided by the voltage ratio of the input and output. Finally the pulsed output voltage is filtered using an L-C filter. Figure 2 shows a typical buck converter application circuit.

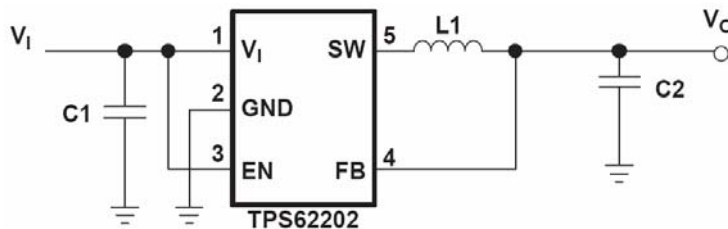

Figure 2. Buck Converter Application Example

When using a single alkaline battery with an output voltage range of approximately 0.9 V to 1.6 V, a boost converter can be used to convert the battery voltage to constant 1.8V. A boost converter normally requires two main passive components for storing energy during the conversion. A boost inductor (L1) and a storage capacitor (C2) at the output are required, and can be seen in the application example of TPS6107x in Figure 3.

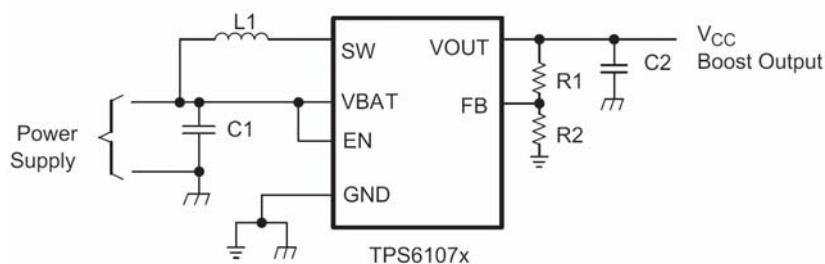

Figure 3. Boost Converter Application Example

A buck-boost converter is used if the input voltage ranges from values above to below the output voltage. It is realized using a buck and a boost converter in series using the same inductor and output capacitor. Figure 4 shows an application circuit example for a buck-boost converter.

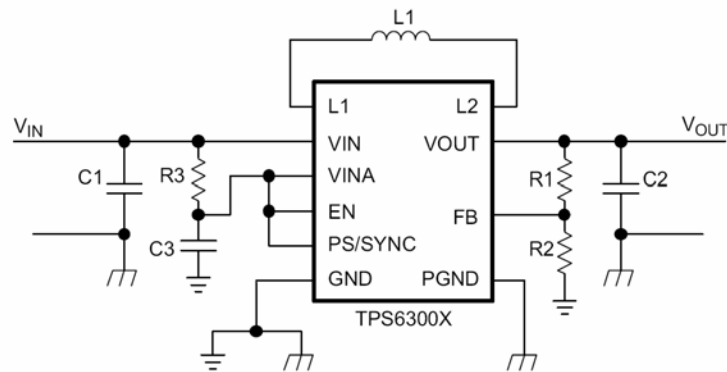

Figure 4. Buck-Boost Converter Application Example

TI offers a wide range of low power DC/DC converters. Recommended converters for LPW applications are: TPS61xxx (Boost), TPS62xxx (Buck) and TPS63000 (Buck-Boost). Detailed information regarding these products is available at www.power.ti.com.

A disadvantage of DC/DC converters, especially in case of RF applications, is the switching noise which can reduce the sensitivity and cause spectral emission. One approach to avoid that the DC/DC converter affects the RF performance is to use a linear voltage regulator between the DC/DC converter and the radio. This so called post regulation is not required if a proper DC/DC converter is chosen.

The main advantage of DC/DC converters compared to linear voltage regulators is high efficiency. The efficiency is up to 95% and nearly independent of the input/output voltage ratio. Standard switch mode converters are switching continuously. This decreases the efficiency with lower load currents. To improve the light load efficiency a power save mode is implemented in many of TI's switch mode converters, see 4.1. However, the quiescent current is still high compared to linear voltage regulators and leads to a reduction in efficiency with decreasing load current. Figure 5 shows an efficiency plot for TPS62200 [2].

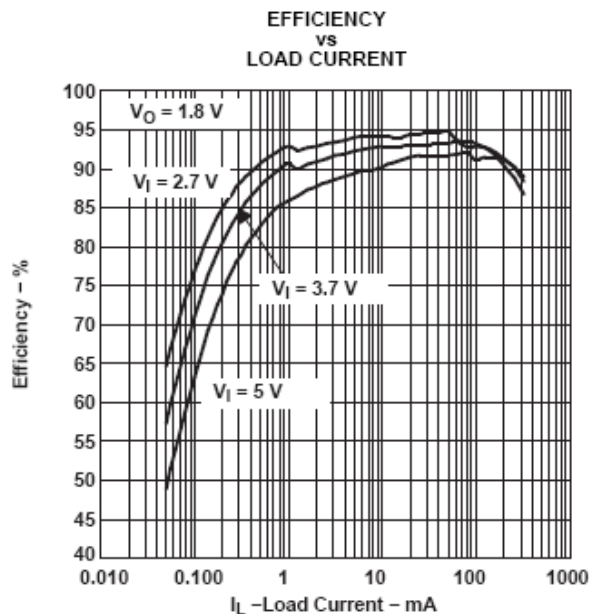

Figure 5. Efficiency Characteristic of TPS62200

The efficiency of DC/DC converters depends mainly on the load current, but the input/output voltage ratio also affects the efficiency. Thus, the efficiency has to be calculated as the ratio between average output and average input power. An easy way to estimate the total efficiency is to use the efficiency plots given in the data sheet and the following equations.

$$\eta_{tot} = \frac{\overline{P_{out}}}{\overline{P_{in}}}$$

Equation 3. Total Efficiency

$$\overline{P_{out}} = \left(P_{out_1} \cdot t_1 + P_{out_2} \cdot t_2 + \dots \right) \frac{1}{\sum t}$$

Equation 4. Average Output Power

$$\overline{P_{in}} = \left(\frac{P_{out_1}}{\eta_1} t_1 + \frac{P_{out_2}}{\eta_2} t_2 + \dots \right) \frac{1}{\sum t}$$

Equation 5. Average Input Power

Equation 3, Equation 4 and Equation 5 then leads to:

$$\eta_{tot} = \frac{\sum (I_n \cdot t_n)}{\sum \left(\frac{I_n}{\eta_n} \cdot t_n \right)}$$

Equation 6. Total Efficiency

The system efficiency can be estimated using Equation 6 together with the efficiency for different load currents. The efficiency of TI's DC/DC converters at different load currents is documented in the data sheet.

3.4 Efficiency Estimation

This section presents efficiency estimations based on CC2500 [8] and TPS62200. CC2500 is a 2.4 GHz transceiver from TI and TPS62200 is a buck converter also from TI. Equation 2 and Equation 6 are used to estimate the efficiency for a linear voltage regulator and a DC/DC converter respectively. The calculations as well as graphical analysis are implemented in an Excel sheet which is available from www.ti.com [5].

A CC2500 with an RX cycle time of 1 second and a duty cycle of 1 % is used to compare the efficiency of a linear voltage regulator and a DC/DC converter. The available battery voltage is 3.6 V and should be converted to 1.8 V to supply the radio.

Cycle Time [us]	1000000
Duty Cycle [%]	1
Input Voltage [V]	3.6
Supply Voltage [V]	1.8
Quiescent Current DC/DC Converter [uA]	15
Quiescent Current Linear Voltage Regulator [uA]	0.5

Table 2. System Parameters

The load configuration in this example is specified in Table 3.

	Crystal Oscillator Startup	IDLE to RX/TX	RX	Sleep
Current [μA]	1500	7400	15700	0.400
Duration [μs]	300	90	10000	989610
DC/DC Converter Efficiency [%]	91	94	95	1.3

Table 3. Load Scenario

3.4.1 Linear Voltage Regulator Efficiency Estimation

Following Equation 2, the efficiency is a function of average current. Therefore the average current is calculated based on the values given in Table 3.

$$\overline{I_{Load}} = \frac{300\mu\text{s} \cdot 1500\mu\text{A} + 90\mu\text{s} \cdot 7400\mu\text{A} + 10000\mu\text{s} \cdot 15700\mu\text{A} + 989610\mu\text{s} \cdot 0.4\mu\text{A}}{300\mu\text{s} + 90\mu\text{s} + 10000\mu\text{s} + 989610\mu\text{s}} = 158.5\mu\text{A}$$

This leads to an average efficiency of:

$$\eta_{AVG} = \frac{V_{out} \cdot \overline{I_{Load}}}{V_{in} (\overline{I_{Load}} + I_q)} = \frac{1.8\text{V} \cdot 158.5\mu\text{A}}{3.6\text{V} (158.5\mu\text{A} + 0.5\mu\text{A})} = 49.8\%$$

3.4.2 DC/DC Converter Efficiency Estimation

According to Equation 6 the total efficiency when using a DC/DC converter is a function of the load current and the corresponding efficiency. The efficiency values at the different load currents for TPS62200 are given in Table 3. The efficiency in sleep mode is calculated based on the quiescent current and the assumption that all losses are included in the quiescent current. The current consumption of CC2500 in sleep mode is 0.4 μA and this leads to efficiency in sleep mode of:

$$\eta_{sleep} = \frac{V_{out} \cdot I_{out}}{V_{out} \cdot I_{out} + V_{in} \cdot I_q} = \frac{1.8\text{V} \cdot 0.4\mu\text{A}}{1.8\text{V} \cdot 0.4\mu\text{A} + 3.6\text{V} \cdot 15\mu\text{A}} = 1.3\%$$

The resulting efficiency following Equation 6 is:

$$\eta_{AVG} = \frac{300\mu\text{s} \cdot 1500\mu\text{A} + 90\mu\text{s} \cdot 7400\mu\text{A} + 10000\mu\text{s} \cdot 15700\mu\text{A} + 989610\mu\text{s} \cdot 0.4\mu\text{A}}{300\mu\text{s} \cdot \frac{1500\mu\text{A}}{0.91} + 90\mu\text{s} \cdot \frac{7400\mu\text{A}}{0.94} + 10000\mu\text{s} \cdot \frac{15700\mu\text{A}}{0.95} + 989610\mu\text{s} \cdot \frac{0.4\mu\text{A}}{0.0132}} = 80.7\%$$

3.5 Efficiency Comparison

The results from the example in section 3.4 leads to a clear efficiency advantage of the DC/DC converter compared to a linear voltage regulator. It is hard to give a general recommendation on which solution that gives best efficiency since the efficiency depends on load current, ratio of input/output voltage and the duty cycle. A general rule is that linear regulators are more efficient for light loads and the maximum efficiency is limited by the input to output voltage ratio. DC/DC converters are more efficient over a wide range of high loads and efficiency decreases for lighter loads.

Figure 6 visualizes this relation between efficiency, duty cycle and cycle time. The plot shows efficiency versus duty cycle for a linear voltage regulator and a DC/DC converter with different cycle times.

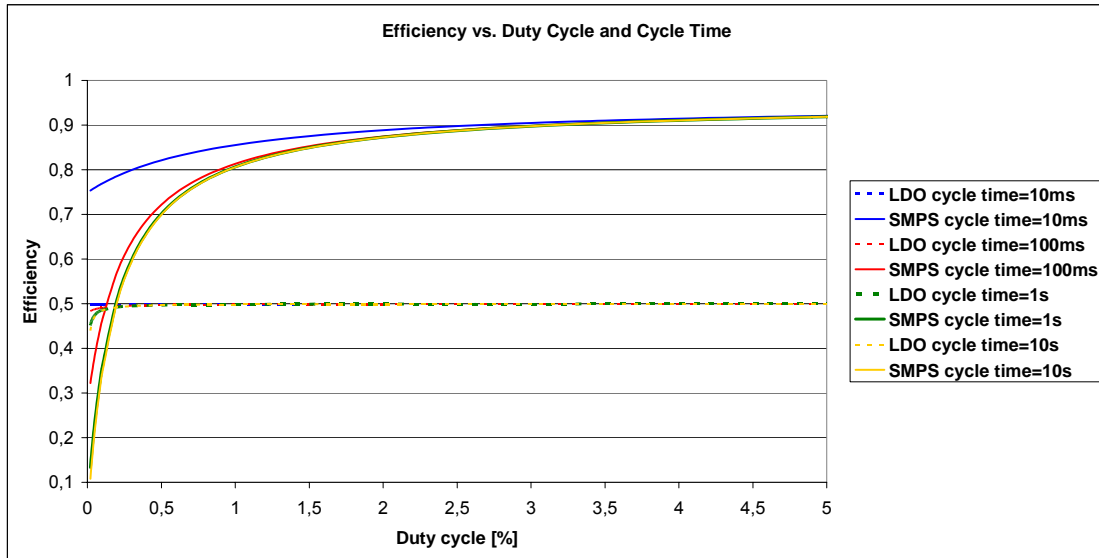

Figure 6. Efficiency vs. Duty Cycle and Cycle Time

For increased duty cycle the efficiency saturates towards the value at active mode. For a linear voltage regulator it is V_{out}/V_{in} and in Figure 6 it is $1.8\text{ V} / 3.6\text{ V} = 50\%$. The maximum efficiency using DC/DC converter is the value at maximum load current and in Figure 6 it is 95%. For lower duty cycles the efficiency in sleep mode is dominating. Thus, efficiency using DC/DC converter decreases significantly while the efficiency using linear voltage regulator remains relatively constant as long as the average load current is large compared to the quiescent current. Due to this characteristic both efficiency curves intersect at a certain point and DC/DC converters become more efficient than linear regulators if the duty cycle is further increased. Larger cycle time results in an interception point at a higher duty cycle. This is because increased cycle time will reduce the percentage of time spent in TX/RX.

These curves depend on the device performance parameter. There are possibly more efficient linear regulators and DC/DC converters than assumed in this case, but the general characteristic is always similar. For more detailed and customized calculations please use the Excel sheet which is available from www.ti.com [5].

4 Switch Noise and Potential Interaction with RF Performance

Supply voltage with low ripple is required to achieve good RF performance. Ripple can impact the sensitivity or generate spurs due to inter-modulation. Potential performance degradation is influenced by different aspects and does not allow a general conclusion. Influencing factors are the DC/DC converter type, its switching frequency, the ripple rejection of the radio's internal voltage regulator, and configuration of the radio in terms of Intermediate Frequency (IF) and receiver filter bandwidth. The recommended IF and receiver filter bandwidth is different for different data rates and different radios. Common for all LPW devices is that the IF and filter bandwidth are optimized with respect to sensitivity, frequency offset, and stable operation across temperature, supply voltage and process variation.

4.1 Light Load Mode

For the three converter topologies described in section 3.3, devices with light load mode, also called power save mode, are available from TI. In this mode, the device reduces unnecessary losses by reducing the switching. The light load mode is implemented slightly different on different devices, but the general approach is always the same.

If a moderate to high current is drawn from the converter it operates like an ordinary DC/DC converter. When the load current goes below a certain level, the converter automatically changes its operation mode to a light load mode. In this operation mode, the converter switches only when the output voltage goes below a set voltage threshold and ramps up the output voltage with one or several pulses until the output voltage reaches a set threshold. This ramp up can be implemented using constant on time and changing the off time, constant off time and changing the on time or using a burst of several pulses followed by a break. These operation modes are often referred to as Pulse Frequency Modulation (PFM) or fixed frequency Pulse Width Modulation (PWM) with pulse skipping. Figure 7 shows inductor current as well as the output voltage of TPS61070 operating in light load mode.

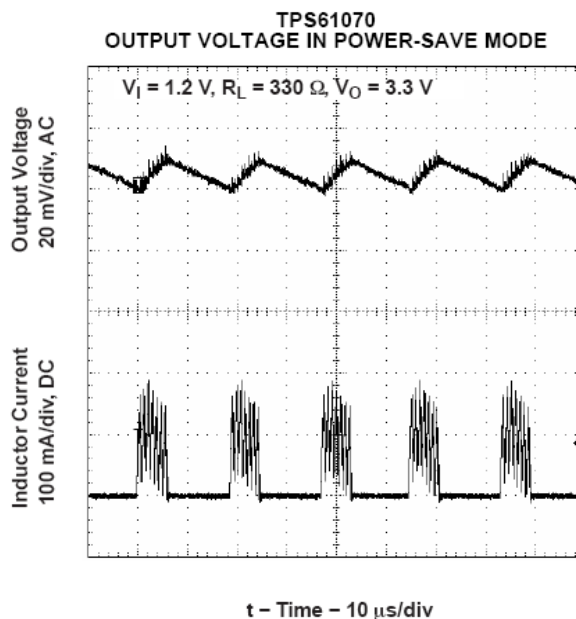

Figure 7. Inductor Current and Output Voltage in Light Load Mode

A PWM converter with pulse skipping charges the output capacitor with a burst of switching pulses up to a certain threshold and switches off until a lower threshold is reached. Depending on the load, the burst frequency is varied while the switching frequency is kept constant. Figure 8, Figure 9, Figure 10 and Figure 11 illustrates the variation of burst frequency while the switching frequency is being kept constant. Light load modes can also be implemented by changing the pulse width and the frequency.

4.2 Switch Noise

Standard PWM switch mode DC/DC converters generate a high but constant switching noise with a constant frequency. All switch mode converters are available with different nominal switching frequencies. Therefore a proper device selection can reduce the potential interference on RF performance.

When switch mode DC/DC converters are operating in light load mode they are either changing the switching frequency or the burst frequency. Due to this, the noise is spread over a wide frequency range when the converters are operating in light load mode. It reaches from the nominal switching frequency in the range of 1-3 MHz down to very low frequencies around a few Hz. The spectral distribution of the noise depends on the load characteristic as well as on how the light load is implemented.

Figure 8 to Figure 11 show measurements of switching noise generated by TPS61070 [3] at different load currents. The figures also show the corresponding plots of voltage between the switch and the inductor, the so called switch node. TPS61070 is a boost converter with 1.13 MHz nominal switching frequency and light load mode. The light load mode is implemented as fixed PWM with pulse skipping.

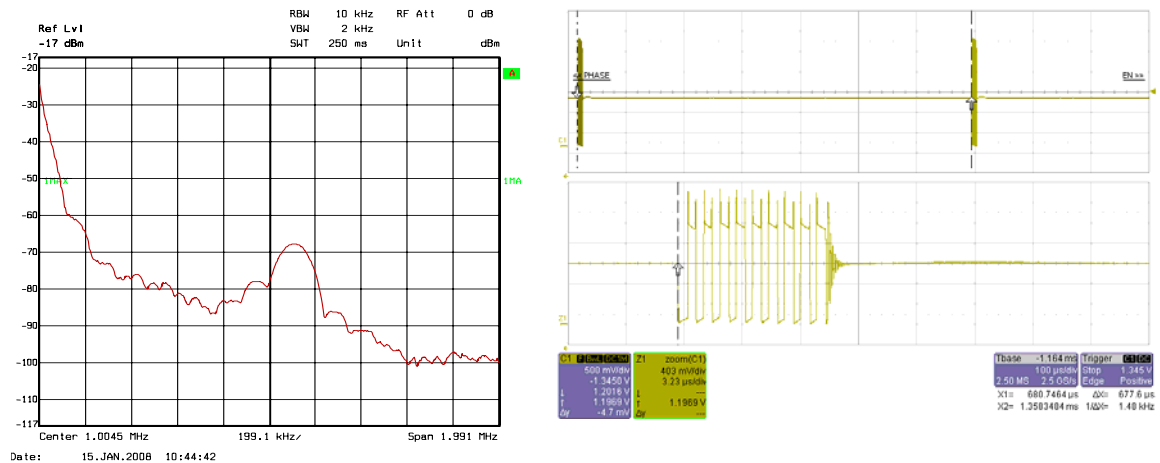

Figure 8. TPS61070 Noise Spectrum and Switching Frequency. $I_{load} = 0.5 \text{ mA}$

Figure 8 shows the noise spectrum at 0.5 mA load current, where the device is switching only rarely. The spectrum shows a low but wide spectral component at the switching frequency. There is no significant noise component at the burst frequency.

By increasing the load current, the switching frequency and the burst frequency becomes more significant in the noise spectrum. This is shown in Figure 9 where the load current is increased to 11 mA. An increased spectral component is observed at 1.13 MHz which is the switching frequency and there is also a significant peak at around the burst frequency which in this case is around 25 kHz.

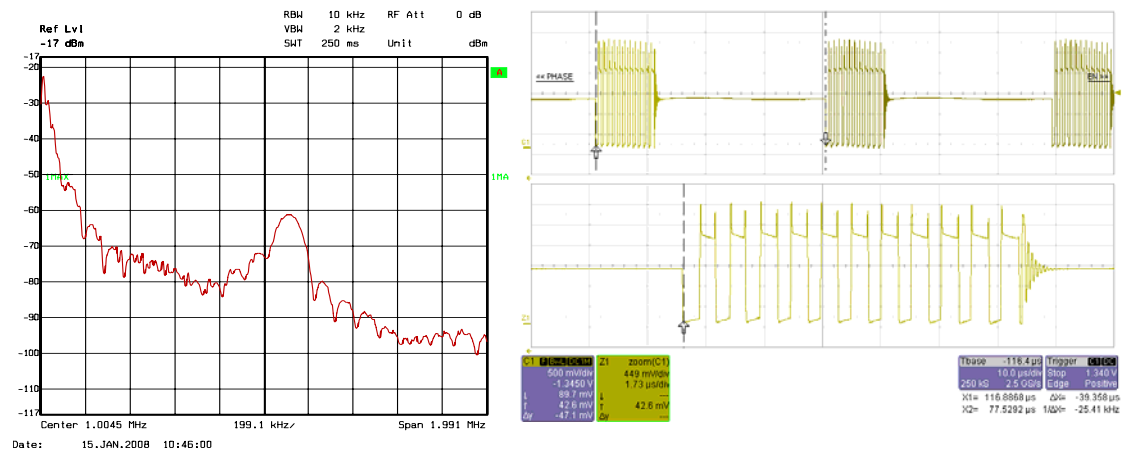

Figure 9. TPS61070 Noise Spectrum and Switching Frequency. $I_{load} = 11 \text{ mA}$

A further increase in load current results in an increased level at the switching frequency. The burst frequency is now approximately 30 kHz which can be seen on the two plots in Figure 10. If the load current is further increased the converter automatically transitions from light load mode to PWM mode. Figure 11 shows the spectrum at 30 mA load current, where the device is in regular PWM mode. In this case the spectral component at the switching frequency increases, but the widely spread noise around the switching frequency decreases. The low noise component caused by the burst frequency is no longer present since the DC/DC converter now operates in a continuous PWM mode with a frequency of 1.13 MHz.

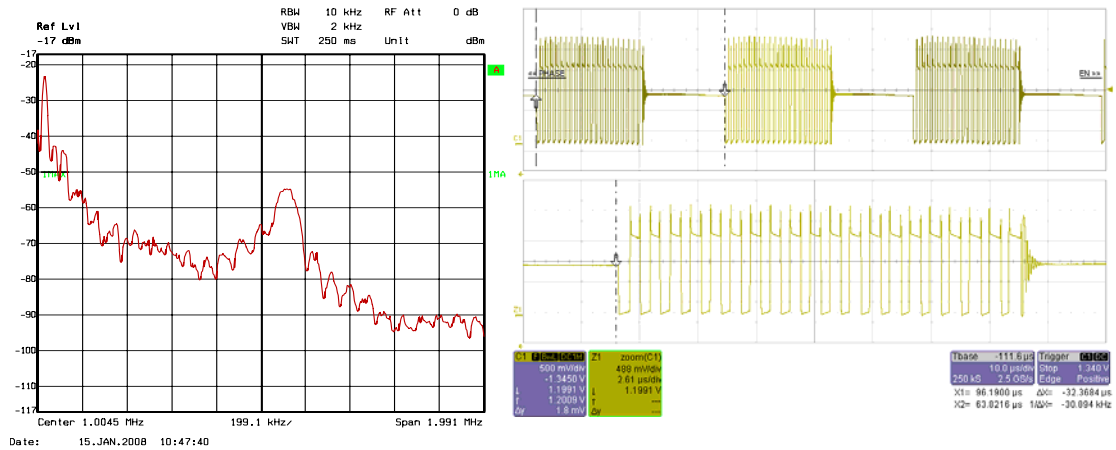

Figure 10. TPS61070 Noise Spectrum and Switching Frequency. $I_{load} = 25$ mA

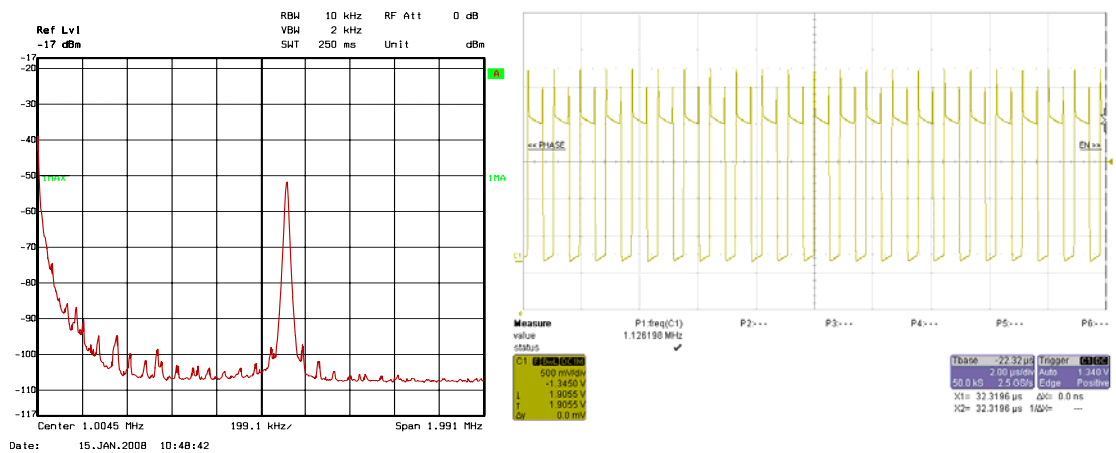

Figure 11. TPS61070 Noise Spectrum and Switching Frequency. $I_{load} = 30$ mA

4.3 Measurements

The sensitivity as well as the spectrum emission of different radios is tested, while the radios are supplied by different DC/DC converters. To achieve the highest possible efficiency, the supply voltage of the radio is in a first step set to around 1.8 V. Since the input voltage of the DC/DC converter influences the switching duty cycle and thus the noise spectrum the input voltage is also varied to simulate different applications regarding battery supply.

4.3.1 Measured Devices and Configurations

To get a good picture about potential performance degradation over a wide range of device combinations different radios as well as different DC/DC converters are tested. The tested radios are:

Device	Type	Test Frequency
CC1101 [6]	Sub 1 GHz ISM band transceiver	868 MHz
CC2430 [7]	2.4 GHz ZigBee System on Chip	2.44 GHz
CC2500 [8]	2.4 GHz ISM band transceiver	2.44 GHz

Table 4: Tested Radios

Design Note DN019

Each of the radios listed in Table 4 is tested in combination with the converters and input voltages listed in Table 5. The only exception is TPS61071 which has only been tested with CC2500.

Device	Type	V _{out}	V _{in}
TPS61070 [10]	Boost with power save	1.85 V	1.2 V, 1.5 V, 1.8 V
TPS61071 [11]	Boost without power save ¹	1.85 V	1.2 V, 1.5 V, 1.8 V
TPS62200 [12]	Buck with power save	1.81 V	3 V, 3.9 V, 4.8 V
TPS63000 [13]	Buck-boost with power save	1.9 V	1.8 V, 2.5 V, 3.2 V

Table 5: Tested DC/DC converter

In addition all radios are tested in different configurations regarding data rate, and thus IF and receiver filter bandwidth. The preferred settings available in SmartRF[®]Studio [14] are used for all tests.

Table 6, Table 7, and Table 8 show the configurations being used when testing the different devices.

Freq. [MHz]	Data Rate [kbps]	Deviation [kHz]	IF freq. [kHz]	RX BW [kHz]	Modulation
868	1.2	5.2	152.3	58.0	ASK
868	1.2	5.2	152.3	58.0	GFSK
868	4.8	25.4	152.3	101.6	GFSK
868	38.4	20.6	152.3	101.6	GFSK
868	250	127.0	304.7	541.7	GFSK
868	250		304.7	541.7	MSK
868	500		355.5	812.5	MSK

Table 6: CC1101 Configuration

Freq. [MHz]	Data rate [kbps]	IF freq. [kHz]	Modulation
2440	250	2000	O-QPSK

Table 7: CC2430 Configuration

Freq. [MHz]	Data Rate [kbps]	Deviation [kHz]	IF freq. [kHz]	RX BW [kHz]	Modulation
2440	2.4	38	203.1	203.1	2-FSK
2440	10	38	152.3	232.1	2-FSK
2440	250		177.7	541.7	MSK
2440	500		304.7	812.5	MSK

Table 8: CC2500 Configurations

¹ Only tested with CC2500

4.3.2 Measurement Results

The above described measurements resulted in two different outcomes.

1. CC1101 & CC2430

Both devices in combination with any of the three DC/DC converters showed no degradation in sensitivity or spurious emission.

2. CC2500

When CC2500 was tested in combination with TPS63000, the performance was as expected. Powering CC2500 with TPS61070 and TPS62200, the expected sensitivity is not reached for data rates above 250 kbps. CC2500 was then tested with TPS61071 which is similar to TPS61070, but without the light load mode. This gave the expected performance and indicates that the performance degradation was caused by the switching frequency being used when TPS61070 and TPS62200 operates light load mode.

5 Conclusion

Testing shows that DC/DC converters can have an impact on the radio performance and especially the sensitivity. The potential sensitivity degradation depends on several factors. It depends on the noise spectrum generated by the DC/DC converter and thus on the DC/DC converter type. The comparison of TPS61070 and TPS61071 results shows that especially the use of DC/DC converters with light load mode can impact the RF performance. Since the noise spectrum heavily depends on the load current, degradation is also dependant on the load current. Thus, the RF performance can also change if additional devices such as sensors, LCD displays, microcontrollers etc. are supplied by the same DC/DC converter and thus change the load profile. It is therefore important to check the sensitivity with the desired regulator and total system load to verify that no degradation occurs. The performance degradation is also dependant on the IF and receiver filter bandwidth configuration of the radio.

5.1 Further Approaches for Reducing the Switch Noise Impact

There are several factors that can influence the performance when using a DC/DC converter together with an RF device. There are no single solutions for all problems, but the following approaches could be used to reduce the impact on the RF performance caused by the DC/DC converter.

- Switch noise can be reduced by low pass filtering the supply voltage.
- By increasing the supply voltage of the radio, the PSRR of the voltage regulator in the radio increases and the switch noise injected into the RF circuit can be reduced [1]. A disadvantage is decreased efficiency, since the efficiency of the internal voltage regulator decreases with increased input voltage.
- By changing the output capacitor on the DC/DC converter, the burst frequency of the light load converter changes and the switch noise spectrum can be changed. On the other hand, it is also important to consider that the nominal output ripple in normal operation mode changes if the output capacitor is changed.
- If a certain spectral component of the switch noise spectrum causes the problem, selecting a different converter with another switching frequency can solve the problem.
- Changing the configuration of the radio in terms of receiver filter bandwidth and IF can decrease the interference. Since any change in IF and RX bandwidth influences also the performance of the radio, a trade off between decreased switch noise interference and decreased RF performance has to be found.
- The easiest but also the least efficient approach is using post regulation, which means an additional linear voltage regulator between the DC/DC converter and the radio. This approach should only be used if a DC/DC converter is mandatory and all other approaches are not successful.

6 References

- [1] Tell, John C.: "Understanding power supply ripple rejection in linear regulators", Analog Applications Journal ([slyt202.pdf](#))
- [2] TPS62200 Data Sheet: ([tps62200.pdf](#))
- [3] TPS61070 Data Sheet: ([tps61070.pdf](#))
- [4] Application Report: "Single-cell Battery Discharge Characteristics Using the TPS61070 Boost Converter" ([slva194.pdf](#))
- [5] Power Consumption spread sheet ([swra173.zip](#))
- [6] CC1101: <http://focus.ti.com/docs/prod/folders/print/cc1101.html>
- [7] CC2430: <http://focus.ti.com/docs/prod/folders/print/cc2430.html>
- [8] CC2500: <http://focus.ti.com/docs/prod/folders/print/cc2500.html>
- [9] CC430: <http://focus.ti.com/docs/prod/folders/print/cc430f6137.html>
- [10] TPS61070: <http://focus.ti.com/docs/prod/folders/print/tps61070.html>
- [11] TPS61071: <http://focus.ti.com/docs/prod/folders/print/tps61071.html>
- [12] TPS62200: <http://focus.ti.com/docs/prod/folders/print/tps62200.html>
- [13] TPS63000: <http://focus.ti.com/docs/prod/folders/print/tps63000.html>
- [14] SmartRF[®]Studio: <http://focus.ti.com/docs/toolsw/folders/print/smartrfm-studio.html>
- [15] Energizer web page: <http://www.energizer.com>

7 General Information

7.1 Document History

Revision	Date	Description/Changes
SWRA173B	2009.09.18	Added CC430 to list of devices
SWRA173A	2009.04.07	Changed title. Cosmetic changes. Added reference to CC1100, CC1100E, CC1110, CC1111, CC2510, and CC2511
SWRA173	2008.04.29	Initial release.

IMPORTANT NOTICE

Texas Instruments Incorporated and its subsidiaries (TI) reserve the right to make corrections, modifications, enhancements, improvements, and other changes to its products and services at any time and to discontinue any product or service without notice. Customers should obtain the latest relevant information before placing orders and should verify that such information is current and complete. All products are sold subject to TI's terms and conditions of sale supplied at the time of order acknowledgment.

TI warrants performance of its hardware products to the specifications applicable at the time of sale in accordance with TI's standard warranty. Testing and other quality control techniques are used to the extent TI deems necessary to support this warranty. Except where mandated by government requirements, testing of all parameters of each product is not necessarily performed.

TI assumes no liability for applications assistance or customer product design. Customers are responsible for their products and applications using TI components. To minimize the risks associated with customer products and applications, customers should provide adequate design and operating safeguards.

TI does not warrant or represent that any license, either express or implied, is granted under any TI patent right, copyright, mask work right, or other TI intellectual property right relating to any combination, machine, or process in which TI products or services are used. Information published by TI regarding third-party products or services does not constitute a license from TI to use such products or services or a warranty or endorsement thereof. Use of such information may require a license from a third party under the patents or other intellectual property of the third party, or a license from TI under the patents or other intellectual property of TI.

Reproduction of TI information in TI data books or data sheets is permissible only if reproduction is without alteration and is accompanied by all associated warranties, conditions, limitations, and notices. Reproduction of this information with alteration is an unfair and deceptive business practice. TI is not responsible or liable for such altered documentation. Information of third parties may be subject to additional restrictions.

Resale of TI products or services with statements different from or beyond the parameters stated by TI for that product or service voids all express and any implied warranties for the associated TI product or service and is an unfair and deceptive business practice. TI is not responsible or liable for any such statements.

TI products are not authorized for use in safety-critical applications (such as life support) where a failure of the TI product would reasonably be expected to cause severe personal injury or death, unless officers of the parties have executed an agreement specifically governing such use. Buyers represent that they have all necessary expertise in the safety and regulatory ramifications of their applications, and acknowledge and agree that they are solely responsible for all legal, regulatory and safety-related requirements concerning their products and any use of TI products in such safety-critical applications, notwithstanding any applications-related information or support that may be provided by TI. Further, Buyers must fully indemnify TI and its representatives against any damages arising out of the use of TI products in such safety-critical applications.

TI products are neither designed nor intended for use in military/aerospace applications or environments unless the TI products are specifically designated by TI as military-grade or "enhanced plastic." Only products designated by TI as military-grade meet military specifications. Buyers acknowledge and agree that any such use of TI products which TI has not designated as military-grade is solely at the Buyer's risk, and that they are solely responsible for compliance with all legal and regulatory requirements in connection with such use.

TI products are neither designed nor intended for use in automotive applications or environments unless the specific TI products are designated by TI as compliant with ISO/TS 16949 requirements. Buyers acknowledge and agree that, if they use any non-designated products in automotive applications, TI will not be responsible for any failure to meet such requirements.

Following are URLs where you can obtain information on other Texas Instruments products and application solutions:

Products

Amplifiers	amplifier.ti.com
Data Converters	dataconverter.ti.com
DLP® Products	www.dlp.com
DSP	dsp.ti.com
Clocks and Timers	www.ti.com/clocks
Interface	interface.ti.com
Logic	logic.ti.com
Power Mgmt	power.ti.com
Microcontrollers	microcontroller.ti.com
RFID	www.ti-rfid.com
RF/IF and ZigBee® Solutions	www.ti.com/lprf

Applications

Audio	www.ti.com/audio
Automotive	www.ti.com/automotive
Broadband	www.ti.com/broadband
Digital Control	www.ti.com/digitalcontrol
Medical	www.ti.com/medical
Military	www.ti.com/military
Optical Networking	www.ti.com/opticalnetwork
Security	www.ti.com/security
Telephony	www.ti.com/telephony
Video & Imaging	www.ti.com/video
Wireless	www.ti.com/wireless

Mailing Address: Texas Instruments, Post Office Box 655303, Dallas, Texas 75265
Copyright © 2009, Texas Instruments Incorporated